

K/M
SERIES



275/K12-900A 275/M50-1200A

Automatic bollards with integrated hydraulic unit

Our best-sellers of all time

Pilomat High Security hydraulic automatic bollards deliver **high performance, long life, and resistance to intensive cycles**, making them ideal for critical infrastructures, airports, government sites, and sensitive areas.

The hydraulic unit is **developed in-house** by our expert team, ensuring maximum quality and optimal performance.

- **Reliable performance in intensive cycles** – ideal for high-traffic areas
- **Optional biodegradable oil** for greater environmental care
- **Extreme protection: up to 2,000,000 J** breakout resistance
- **Certified to PAS68, IWA 14-1, ASTM** international standards
- They withstands **(K12/M50 level) impacts** with a truck at 80 km/h
- **The only EPD-certified bollards in the world:** security and sustainability.

Smart! Faster maintenance with **external hydraulic unit for systems with up to 3 bollards**



Standard configuration

The standard configuration of our systems is designed to ensure efficiency, safety and ease of management. The configuration includes:

- **Anthracite grey painted steel bollard**, a device for controlling vehicle access
- **Foundation box**, an underground structure housing the bollard
- **Control unit**, manages the operation of the bollard.



TRIPLE CERTIFICATION
PAS68, IWA14, ASTM



Reg. EPDITALY0412
Valid. 25.05.2028
www.epditaly.it

Mod. 275/K12-900A

PILOMAT
HÖRMANN

Pilomat S.r.l.
Via Zanica 17/P, Grassobbio (BG) Italia
pilomat@pilomat.com www.pilomat.com



K/M
SERIES



275/K12-900A 275/M50-1200A

Automatic bollards with integrated hydraulic unit

	275/K12-900A	275/M50-1200A
Cylinder material	S355JR normal steel - X5CrNi 18-10 (AISI 304) - X5CrNiMo 17-12-2 (AISI 316) stainless steel	
Cylinder diameter	271mm	
Cylinder height	900mm	1200mm
Cylinder thickness	23mm	
Movement principle	Hydraulic	
Cylinder normal steel finish	Anti-corrosion treatment - grey anthracite standard painting	
Cylinder stainless steel finish	Grey anthracite standard painting or brushing	
Reflecting adhesive strip	Standard - height 55mm	
Rising time	4s	5,5s
EFO rising time	1,5s	
Lowering time	4s	4s
Emergency lowering	Standard	
Connection line to control unit	Standard 10m (max 80m - with heating element max 50m)	
Voltage for control unit	230/400 VAC (+/- 10%) 50/60Hz	
Hydraulic pump	Built-in the bollard	
Protection class	IP 67	
Type of use	2000 Cycles/day	
Life units	3.000.000 Cycles	
Impact resistance	700.000J	
Breakout resistance	2.000.000J	
Certified to	PAS68, IWA 14-1, ASTM M50 (K12)	
Nominal operating temperature	-40°C +70°C (for low temperatures see heating resistance)	
Load class (EN124)	D400	

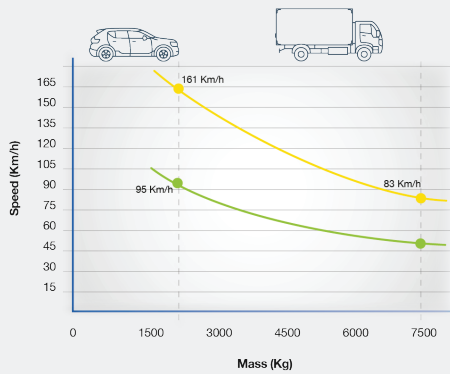

Impact resistance ● 700,000 J
Breakout resistance ● 2,000,000 J

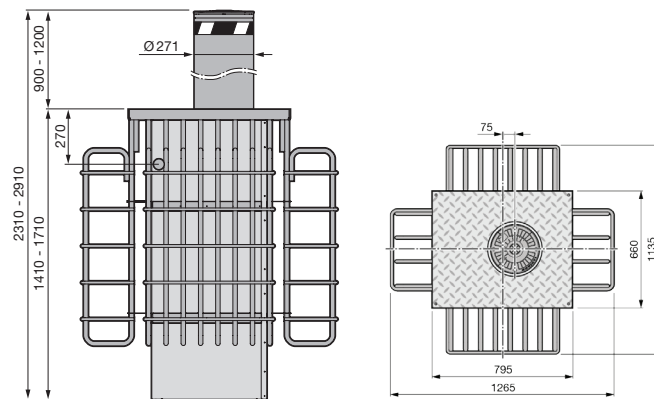

PILOMAT
HÖRMANN

Pilomat S.r.l.
Via Zanica 17/P, Grassobbio (BG) Italia
pilomat@pilomat.com www.pilomat.com

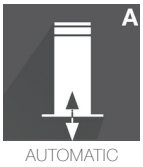

K/M
SERIES



275/K12-900A 275/M50-1200A

Automatic bollards with integrated hydraulic unit

Pilomat offers **safety accessories** for every installed system: including photocells, flashing lights and acoustic sensors for emergency vehicles. Each device is designed to **ensure maximum efficiency, clear signaling and secure control.**

Available finishes

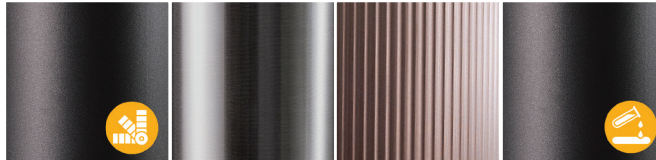

RAL painting

Brushing

Knurling

Anti-corrosion
marine treatment

Safety and visibility

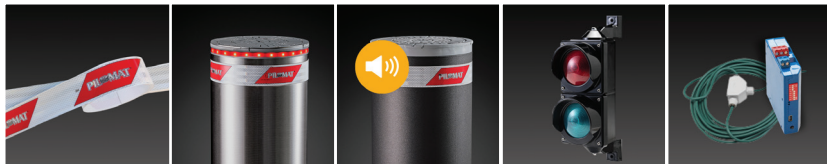

Reflecting strip

LED lighting strip

Warning signal

Traffic light

Induction loops

Special design



Custom cover
plate

RAL painted
cover

Custom
inclination

Fillable tank for
paving stones

Functions



Automatic
lowering

EFO (Fast
emergency
operation)

Heating element

UPS unit

External
hydraulic unit

Sensors: alarm,
crash

PILOMAT
HÖRMANN

Pilomat S.r.l.
Via Zanica 17/P, Grassobbio (BG) Italia
pilomat@pilomat.com www.pilomat.com

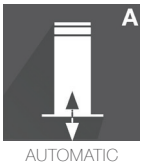

K/M
SERIES



275/K12-900A 275/M50-1200A

Automatic bollards with integrated hydraulic unit

Pilomat provide a complete range of **control devices**, designed to make the use of installed systems practical and immediate. Buttons, selector and remote controls allow users to operate the devices with a single gesture, **ensuring immediate, reliable control and intuitive management.**

Control devices



Key switch



Card reader



Numeric key pad



Finger scan



Hand transmitter



License plate reader

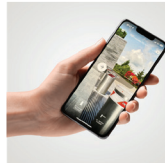

App or Bluetooth



Timer
(week - year)

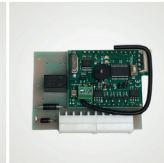

GSM activator



P-Connect



Cloud Unit W5-B



PILOMAT
HÖRMANN

Pilomat S.r.l.
Via Zanica 17/P, Grassobbio (BG) Italia
pilomat@pilomat.com www.pilomat.com